

CAPSULHELIC® DIFFERENTIAL PRESSURE GAGE

Measures Pressure, Vacuum or Differential, Suitable for Internal Pressures to 500 psig

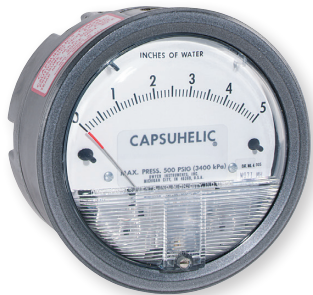

Capsuhelic® pressure gage has a large, easy-to-read 4" (102 mm) dial.

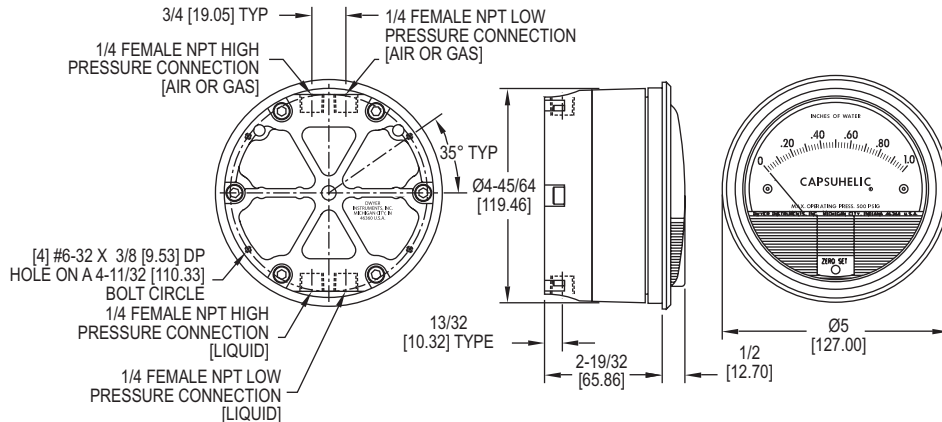

The **Series 4000 Capsuhelic® Differential Pressure Gage** is designed to give fast, accurate indication of differential pressures. The gage may be used as a readout device when measuring flowing fluids, pressure drop across filters, liquid levels in storage tanks and many other applications involving pressure, vacuum or differential pressure.

The pressure being measured is held within a capsule which is an integral part of the gage. This containment of the pressure permits the use of the gage on system pressures of up to 500 psig, even when differentials to be read are less than 0.1 in w.c.

FEATURES/BENEFITS

- Gage capsule permits high-pressure usage with small differentials
- Zero and range adjustments outside of gage means no disassembly in normal service
- Time-proven, simple, frictionless movement that permits full-scale readings as low as 0.5 in w.c.
- Diaphragm-actuated versus liquid filled gage supports outdoor use

APPLICATIONS

- Fluid flow
- Liquid storage tanks
- Filter pressure drops
- Vacuum or differential pressure

Note: May be used with hydrogen where pressures are less than 35 psi. Order with a Buna-N diaphragm.

MODEL CHART			
Model	Range	Model	Range
4005*	0-5.0 in w.c.	4310	5-0-5 in w.c.
4006*	0-6.0 in w.c.	4330	15-0-15 in w.c.
4010*	0-10 in w.c.	4205	0-5 psid
4015*	0-15 in w.c.	4210	0-10 psid
4020*	0-20 in w.c.	4215	0-15 psid
4025*	0-25 in w.c.	4220	0-20 psid
4030*	0-30 in w.c.	4616B**	0-16 ft w.c.
4040*	0-40 in w.c.	4635	0-35 ft w.c.
4050*	0-50 in w.c.		
4060*	0-60 in w.c.		
4080*	0-80 in w.c.		
4100*	0-100 in w.c.		
4200*	0-200 in w.c.		

*These ranges available for vertical scale position only.
**Available only with the brass case for water service.
Note: Scales reading directly in flow, heights, etc., are also available.

SPECIFICATIONS

Service: Aluminum case: Air and compatible gases and oil based liquids; Brass case: Air and compatible gases and water based liquids.
Wetted Materials: Consult factory.
Housing: Die cast aluminum with impregnated hard coating, standard. Optional forged brass housing is required for water or water based fluids. Special material diaphragms available, contact factory.
Accuracy: ±3% of FS at 70°F (21.1°C). (±4% on 4200, 4210, 4215, 4220, 4300, 4400, and 4500).
Pressure Limits: -20" Hg to 500 psig (-0.677 bar to 34.4 bar).
Temperature Limits: 20 to 200°F (-6.67 to 93.3°C).
Size: 4" (101.6 mm) diameter dial face.
Mounting Orientation: Diaphragm in vertical position. Consult factory for other position orientations.
Process Connections: 1/4" female NPT high and low pressure taps, duplicated - one pair top for air and gas, and one pair bottom for liquids.
Weight: 3 lb, 3 oz (1.45 kg) aluminum case; 7 lb, 13 oz (3.54 kg) brass case.

OPTIONS

To order add suffix:	Description
-ASF	Adjustable signal flag
B	Brass case
Scale Overlays	Red, green, mirrored or combination; specify locations
-NIST	NIST traceable calibration certificate

ACCESSORIES - STANDARD

Description
Two 1/4" NPT plugs for duplicate pressure taps, four flush mounting adapters with screws and four surface mounting screws.

ACCESSORIES

Model	Description
A-298	Flat flush mounting bracket
A-309	3-way manifold valve
A-314	Bleed fitting
A-370	Mounting bracket
A-471	Portable kit
A-496	Flush mount bracket
A-610	Pipe mount kit

USA: California Proposition 65
⚠️WARNING: Cancer and Reproductive Harm - www.P65Warnings.ca.gov

Process Tubing Options: See page 455 (Gage Tubing Accessories)